

FLOWTRON[®] *electric* Leaf Eater

the Ultimate MULCHER

SHREDS LEAVES, GRASS CLIPPINGS, PINE NEEDLES . . .

OWNER'S MANUAL

Model
LE-900F

- Assembly
- Operation
- Maintenance
- Repair Parts



WARNING

Carefully read and follow safety rules, precautions and operating instructions. Failure to do so can result in serious personal injury.

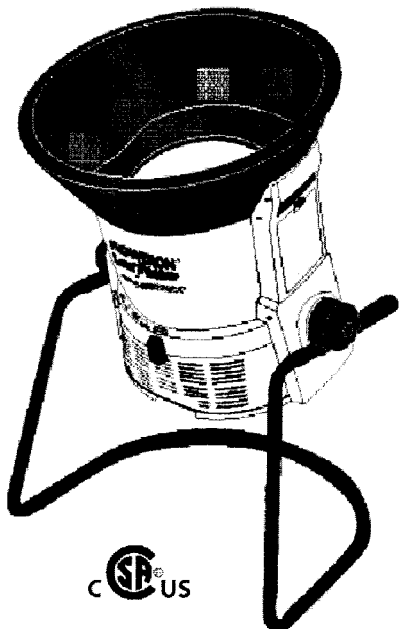

Always Wear Eye Protection During Operation

ONE Year Limited Warranty on FLOWTRON LEAF-EATER THE ULTIMATE MULCHER — LE-900F

FLOWTRON, division of Armatron warrants your Flowtron Leaf-Eater to be free from defects in materials or workmanship under normal use and service for one year from date of the original purchase. All parts which are defective will be repaired or replaced free of charge. Any implied warranties, including the implied warranty of merchantability are also limited in duration for one year from the original purchase date. Some states do not allow limitations on how long an implied warranty lasts, so the above limitations may not apply to you.

The provisions of this warranty shall not apply to any Flowtron Leaf-Eater which has been subject to misuse, neglect or accident, nor which is used for a purpose for which it is not designed, or which shall have been repaired or altered in any way so as to adversely affect its performance and reliability. Service by unauthorized parties voids your warranty. Warranty covers only the original purchaser. Commercial and/or professional use is excluded from warranty coverage.

Flowtron neither assumes nor authorizes any person to assume for it any other liability in connection with its products. No responsibility is assumed for any consequential damages that may result from the use of a Flowtron product, not for damages due to accident, abuse, lack of responsible care, the affixing of any unauthorized attachments, loss of parts or subjecting this unit to any but the specified voltage. Some states do not allow the exclusion or limitation of the incidental or consequential damages, so the above limitation or exclusion may not apply to you.

This warranty gives you specific legal rights, and you may also have other rights which vary from state to state.

FLOWTRON Outdoor Products, 15 Highland Ave, Malden, MA 02148 • an ARMATRON Co.

TABLE OF CONTENTS

	PAGE
Warranty	2
Know Your Flowtron Ultimate Leaf-Eater	3
Assembly	4,5
1. Assemble Funnel	4
2. Attach Funnel to Housing	4
3. Assemble Legs	5
4. Attach Spacer and Handle Grips to Legs	5
5. Assemble Housing to Legs	5
Safety Rules and Precautions	6
Electrical Requirements	7
Motor Information	7
Safe Operating Instructions	8
1. Moving Your Unit	8
2. Loading Your Unit	8
3. Mulching Control Lever	8
Maintenance	9
1. Cleaning Your Unit	9
2. Replacement of Cutting Line	9
3. Replacement of Spinner	9
4. Cleaning Air Filter	9
5. Storage	8
Trouble Shooting	9
Exploded View	10
Parts List	11

Model # _____

Serial # _____

The model and serial number will be found on the decal attached to the underside of the motor duct housing.

You should record both model and serial numbers and keep in a safe place for future reference.



Instructions given with this symbol are for personal safety. Be sure to follow them.

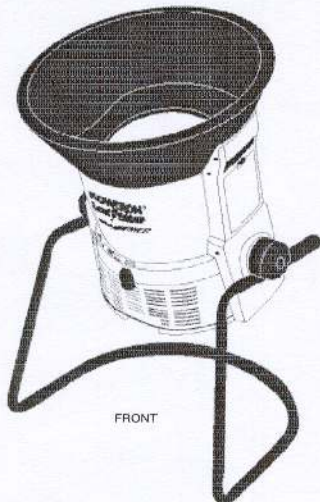

FIGURE 1

PREPARATION

Your Owner's Manual has been developed to help you assemble the unit and to understand its safe operation. It is important that you read your manual completely to become familiar with the unit before you begin assembly.

1. Tools you will need

#2 phillips head screwdriver



1. Assemble Funnel

Place funnel halves on flat surface with narrow opening facing up. Align both halves and press locating pin nearest narrow opening of funnel half into locating hole on adjacent funnel half. See figure 3. Repeat for other side.

NOTE: Flange on funnel half overlaps outer surface of adjacent funnel half as shown in figure 3.

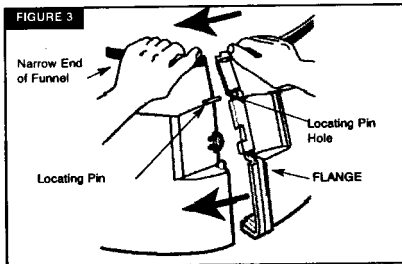

Reverse funnel by placing narrow opening down. Press locating pin nearest large opening of funnel half into locating hole on adjacent funnel half. See figure 4. Repeat for other side.

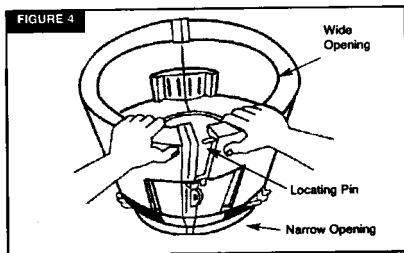

2. Attach Funnel to Housing

Place narrow opening of funnel on upper edge and position funnel so that flat areas of funnel are located at the right and left housing towers. Press funnel with hole at top center of housing tower. Repeat for opposite side. When both sides are aligned, press funnel firmly down onto housing. Apply pressure all around edge of funnel until it is seated evenly around the housing. Fasten funnel to right side of housing by inserting a #10 x 3/16 inch head phillips screw into large screw hole on top front edge of housing tower, and tighten with phillips screwdriver. **CAUTION:** Do not over-tighten screw. See figure 5. Repeat for left side.

NOTE: While inserting screw into screw hole, keep funnel tab in place by pressing down on top surface of funnel opposite tab so that screw hole is through hole in funnel tab.

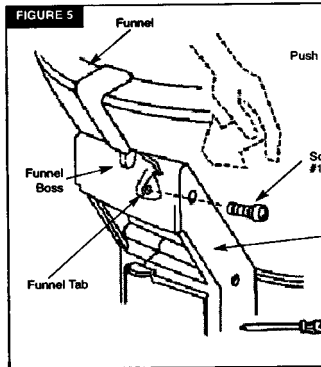

PREPARATION

Your Owner's Manual has been developed to help you assemble the unit and to understand its safe operation. It is important that you read your manual completely to become familiar with the unit before you begin assembly.

1. Tools you will need

#2 phillips head screwdriver



1. Assemble Funnel

Place funnel halves on flat surface with narrow opening facing up. Align both halves and press locating pin nearest narrow opening of funnel half into locating hole on adjacent funnel half. See figure 3. Repeat for other side.

NOTE: Flange on funnel half overlaps outer surface of adjacent funnel half as shown in figure 3.

FIGURE 3

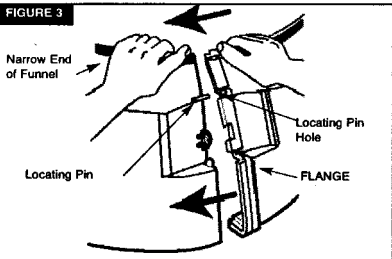

Reverse funnel by placing narrow opening down. Press locating pin nearest large opening of funnel half into locating hole on adjacent funnel half. See figure 4. Repeat for other side.

FIGURE 4

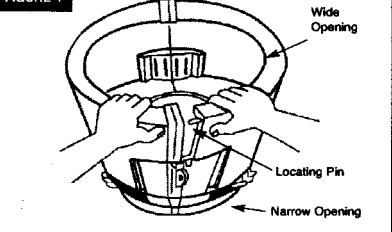

2. Attach Funnel to Housing

Place narrow opening of funnel on upper end of housing and position funnel so that flat areas of funnel are located at the right and left housing towers. Align boss on funnel with hole at top center of housing tower as shown in figure 5. Repeat for opposite side. With bosses aligned, press funnel firmly down onto housing. Apply pressure all around edge of funnel until funnel is seated evenly around the housing. Fasten funnel to right side of housing by inserting a #10 x 3/4" long pan head phillips screw into large screw hole opening at top front edge of housing tower, and tighten using a phillips screwdriver. **CAUTION:** Do not over tighten screw. See figure 5. Repeat for left side.

NOTE: While inserting screw into screw hole opening, keep funnel tab in place by pressing down on inside surface of funnel opposite tab so that screw passes through hole in funnel tab.

FIGURE 5

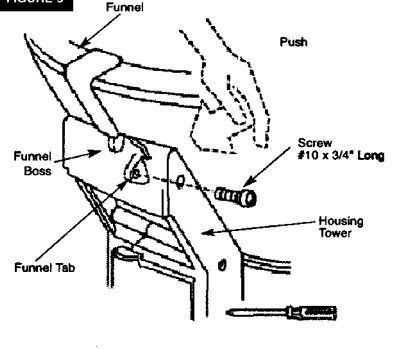

3. Assemble Legs

Connect curved leg sections to form a semi-circle by attaching the upper and lower leg clamps and tightening with four #8 x 5/8" screws and #8-32 hex nuts using a phillips screwdriver. See figure 6.

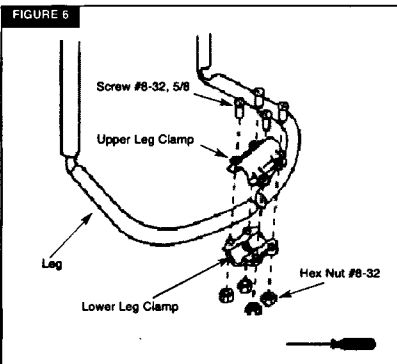

4. Attach Spacer and Handle Grips to Legs

Locate holes on sides of horizontal portion of leg sections. Holes are located approximately 7" from end of leg.

Install a spacer on a #8 x 1/2" pan head phillips screw and fasten to outside surface of leg using a phillips screwdriver. Repeat for opposite side. See figure 7.

Place handle grips on horizontal ends of both leg sections.

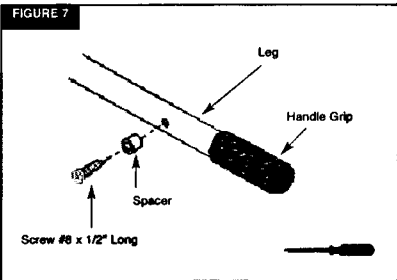

⚠ Do not remove friction pads located on left and right threaded stems.

5. Assemble Housing To Legs

Remove knobs and hubs from both sides of the housing by unscrewing knob and pulling hub off threaded stems located on either side of the housing. See figure 8.

Place housing on legs with funnel facing downward. Position with Flowtron Leaf-Eater label facing semi-circle, and with threaded stems of housing above leg spacers. Place hub on leg making certain that spacer on leg passes through slot on hub. See figure 8.

Insert threaded stem through hole in center of hub and fasten by threading knob onto stem. **DO NOT OVER TIGHTEN.** Repeat for opposite side. Position unit at desired angle and tighten left and right knobs

⚠ When making large changes in housing angle or when placing housing in the storage position, Loosen knobs before rotating.

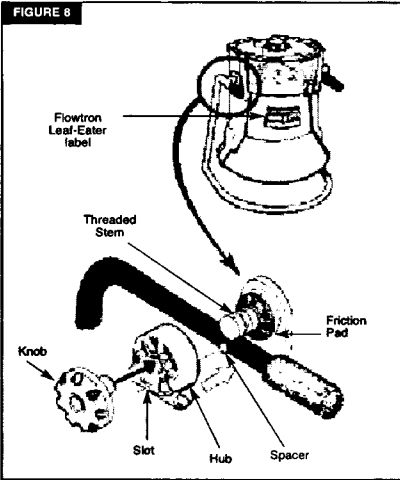

SAFETY RULES AND PRECAUTIONS

Warning: To reduce the risk of fire, electric shock, and personal injury, the following basic safety precautions should always be followed.



READ ALL INSTRUCTIONS

1. Become familiar with all sections of this owner's manual before attempting to operate the shredder. This shredder should be used solely for the purpose it was intended.
2. Use only parts or accessories specifically designed for use with this shredder. Using other parts or accessories could increase risk of injury.
3. Keep Children Away – all visitors should be kept at a distance from the work area.
4. Never allow your hands or any part of your body or clothing inside the upper housing area.
5. Avoid Dangerous Environments – do not use shredder in damp or wet locations. Do not operate or store shredder in wet areas. Do not operate in rain. Store indoors when not in use, in a dry, and high or locked-up place – out of reach of children.
6. This shredder should be operated on a solid, level surface.
7. Dress Properly – do not wear loose clothing or jewelry. They can be caught in moving parts. Use of work gloves and substantial footwear is advised when working outdoors. Wear protective hair covering to contain long hair.
8. Stay Alert – Watch what you are doing. Use common sense. Do not operate shredder when you are tired.
9. Do not Abuse Power or Extension Cords – Never carry unit by its power cord or yank cord to disconnect from receptacle. Keep all cords clean and away from heat, oil and sharp edges and inspect for damage before each use.
10. Ground unit properly. Follow instructions on page 7 when connecting to electrical outlet.
11. Warning – To reduce the risk of electrical shock, use only an extension cord intended for outdoor use. See page 7 for additional information on extension cords.
12. Ground fault circuit interrupter (GFCI) protection should be provided on the circuit(s) or outlet(s) to be used for this shredder. Receptacles are available having built-in GFCI protection and may be used for this measure of safety.
13. If it is necessary for any reason to inspect, clean or repair the shredder, turn the shredder off and wait until it comes to a complete stop, then disconnect the power cord before attempting such inspection or repair.
14. Disconnect shredder from the power source when not in use, before servicing, and when changing cutting lines.
15. When feeding material into the shredder be extremely careful that pieces of metal, rocks, bottles, cans or other foreign objects are not included.
16. Do not force the shredder. It will do the job better and with less likelihood of a risk of injury when used at the rate for which it was designed.
17. If the cutting mechanism strikes a foreign object or if your shredder should start making an unusual noise or vibration, immediately switch it off, wait until the shredder has come to a complete stop, then disconnect the power cord and take the following steps:
 - A. Remove any foreign or clogged material.
 - B. Check for any loose parts and tighten to assure continued safe operation.
 - C. Replace or repair any damaged parts.
18. Avoid unintentional starting. Be sure switch is off when plugging in the shredder.
19. Always use safety glasses. Wear face or dust mask if operation is dusty.
20. Check discharge area periodically after stopping shredder to assure the processed material does not build up and clog motor cooling vents.
21. Do Not Overreach – keep proper footing and balance at all times.
22. Do not move shredder when motor is running or with finger on the switch.
23. Maintain Shredder With Care – Follow instructions for replacing cutting lines and for cleaning air filter. Inspect shredder power cord periodically, and if damaged, have it repaired by an authorized service facility. Keep handles dry, clean, and free from oil and grease.
24. Check Damaged Parts – Before further use of the shredder, any part that is damaged should be carefully checked to determine that it will operate properly and perform its intended function. Check for alignment of moving parts, binding of moving parts, breakage of parts, mounting, and any other condition that may affect its operation. A guard or other part that is damaged should be properly repaired or replaced by an authorized service center unless indicated elsewhere in this manual.

SAVE THESE INSTRUCTIONS

ELECTRICAL REQUIREMENTS

Important: Use a 14 ga. or heavier extension cord with a maximum length of 100 ft.

Grounding Instructions

This shredder should be grounded while in use to reduce the risk of electric shock to the operator.

The shredder is equipped with a three-conductor cord and three-prong grounding plug. The green or green and yellow conductor in the cord is the grounding wire. Never connect the green or green and yellow wire to a live terminal.

The shredder is intended for use on a circuit that has a grounded outlet box that looks like the one illustrated in figure 9, sketch A.

An adapter which looks like the adapter illustrated in figure 9, sketch B is available for connecting three-prong plugs to two-prong receptacles. The green colored rigid ear, lug, or the like on the adapter, must be connected to a permanent ground, such as a properly grounded outlet box, using a metal screw.

Check with a qualified electrician or serviceman if the grounding instructions are not completely understood, or if in doubt as to whether the shredder is properly grounded.

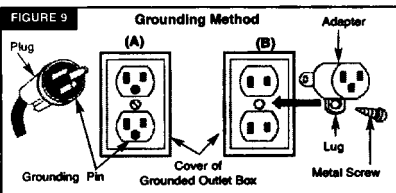

Extensions Cords

Only use three-wire extension cords that have three-prong grounding plugs and three-hole receptacles that accept the shredder's plug. When using an extension cord, make sure that it is in good condition.

Use a 14 ga. or heavier extension cord with a maximum length of 100 ft. An undersized extension cord will cause a drop in line voltage resulting in loss of power and overheating.

Warning – To reduce the risk of electric shock, only use extension cords intended for outdoor use, such as cord types SW-A, SOW-A, STW-A, STOW-A, SJW-A, SJOW-A, SJTW-A or SJTOW-A.

To prevent disconnection of the shredder cord from the extension cord during operation, make a knot as shown in figure 10. Devices for retaining extension cords are also available at your local hardware retailer.

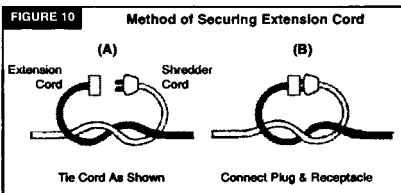

MOTOR INFORMATION

1. ON/OFF Switch

The ON/OFF switch is located on the side of the housing. To turn unit "on", push switch to "ON" position. To turn unit "OFF", push switch down to "OFF" position. See figure 11.

2. Circuit Breaker Reset Button

The circuit breaker/reset button is located under the Flowtron Leaf-Eater enclosure on the side of the motor housing as shown in figure 11. The unit is designed to shut down in the event of an overload. To restart, shut off switch, wait approximately three minutes, push reset button, and place switch to ON position.

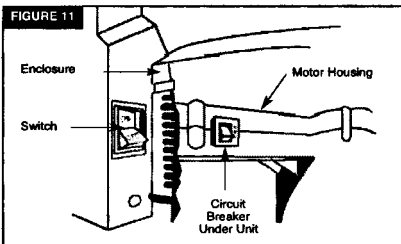

SAFE OPERATING INSTRUCTIONS

Your Flowtron Ultimate Leaf-Eater can be hazardous if improperly or carelessly used. The instructions and figure shown below demonstrate the right way to use your machine. Read and understand the operating instructions before you operate your machine. Always use safe and cautious operating methods. Please remember, the operating and safety instructions have been written for your use. Failure to read all instructions may result in injury. Be sure you have read "Rules for Safe Operation" on page 6 before proceeding.

⚠ Disconnect power cord from extension cord before moving machine from one location to another location.

1. Moving Your Unit

Disconnect the power cord from the extension cord or power source, grasp the unit along the top of the housing tower, lift and move to wherever you choose. To place unit on trash container, lift by grasping hand grips located on leg extensions. To use on legs with leaf bag, place bag around unit and retain with bungee cord. See figure 12.

FIGURE 12

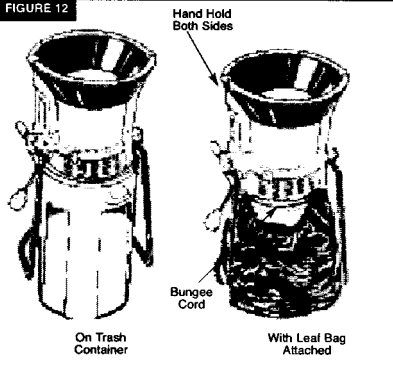

⚠ Filling hopper with unshredded material at a rate faster than the machine can handle may result in permanent damage to your motor.

2. Loading Your Machine

With the machine running, feed double handfuls of dry leaves, or single handfuls of wet leaves, into the hopper. Allow the machine to shred the load completely and regain speed before reinserting the next load. Do

⚠ To avoid damage to your motor, the mulching control lever must be in the proper position when shredding grass clippings, thatch or pine needles.

not overload the machine by letting it labor at low speed: this will cause the circuit breaker to shut the motor off. If this happens, turn the switch off, unplug the machine, clear the unshredded material from the hopper, reset the breaker and continue with your shredding.

3. Mulching Control Lever

The control lever, see figure 13, controls the particle size and speed at which material goes through the unit. With the control lever in the COARSE position, material will process through the unit faster but will give you a larger particle size than if the lever were in the FINE position. The FINE position setting will discharge material slower, but will give the smallest particle size. Use special settings for pine needles, grass clippings and thatch. For best results, material should be shredded when dry.

FIGURE 13

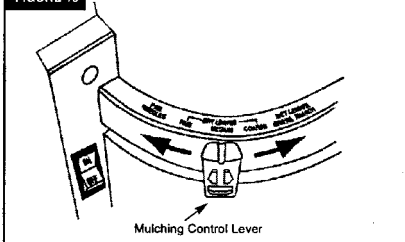

⚠ Do not allow shredded material in trash container or leaf bag to reach bottom of Motor Housing. A reduction in airflow will result and may cause permanent damage to your motor.

1. Cleaning Your Unit

Your unit requires a minimum of maintenance other than cleaning. It is recommended that you clean out built-up residue from inside the housing area during and after each use. Replace cutting line as often as necessary, see paragraph 2 below, and clean air filter frequently, see paragraph 4 below. Any other maintenance or repairs should be performed by Flowtron.

2. Replacement of Cutting Line

Your unit is supplied with six strips of six (6) cutting lines each (for a total of 36 cutting lines). To separate individual lines simply pinch the indent between lines nearest strip end and peel away.

Replace cutting cord when a noticeable decrease in shredding efficiency is observed. To remove used cutting lines pull used line out of the spinner head inside the housing. To install new cutting lines place each end of new line through the two holes in the post on top of the spinner head and pull through so that both ends of the line are even. Thread lines through the two ferrules on the side of the spinner head and pull tight so that ends are even. See fig. 14.

FIGURE 14

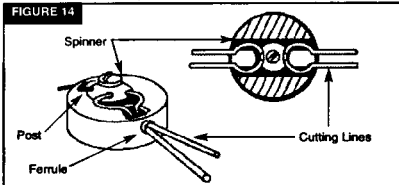

WARNING: Use .080 to maximum .090 diameter monofilament cord 12 3/4" long. Use of thicker lines, lines made of substitute materials, or lines greater than 12 3/4" long **MAY RESULT IN PERMANENT DAMAGE TO YOUR MOTOR AND/OR INJURY.**

3. Replacement of Spinner

Remove screw and "O" ring from center of spinner. Lift spinner off shaft. Place new spinner over shaft and turn until hex falls in place. Tighten screw until "O" ring is depressed slightly.



Do not attempt to run or use your machine with the air filter removed. Check frequently to insure air filter is clean. Always disconnect power cord prior to removing air filter.

4. Cleaning Air Filter

The removable air filter is located on the side of the housing tower. To remove, grasp filter with fingers and pull out of compartment. (See figure 15.) Rinse with clear water and air dry. Replace air filter before using machine.

5. Storage

To reduce storage space requirements, loosen knobs and rotate unit 180°, (funnel facing downward).

FIGURE 15

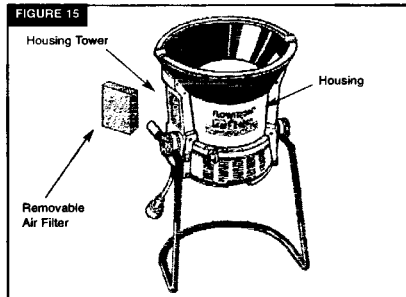

TROUBLE SHOOTING

Symptom	Problem	Correction
Motor will not start.	No electric power.	Check to be sure power cord is connected to power source.
No cutting action/lack of power.	Cutting line is worn or residue has built up inside of housing.	Replace cutting line with new line. Clean built-up residue in housing.
Open circuit breaker	Oversize or incorrect cutting line. Feeding material too fast.	See section 2 page 9. See section 2 page 8.

FLOWTRON LEAF-EATER THE ULTIMATE MULCHER

Exploded View — FLOWTRON ELECTRIC LEAF-EATER #LE-900F

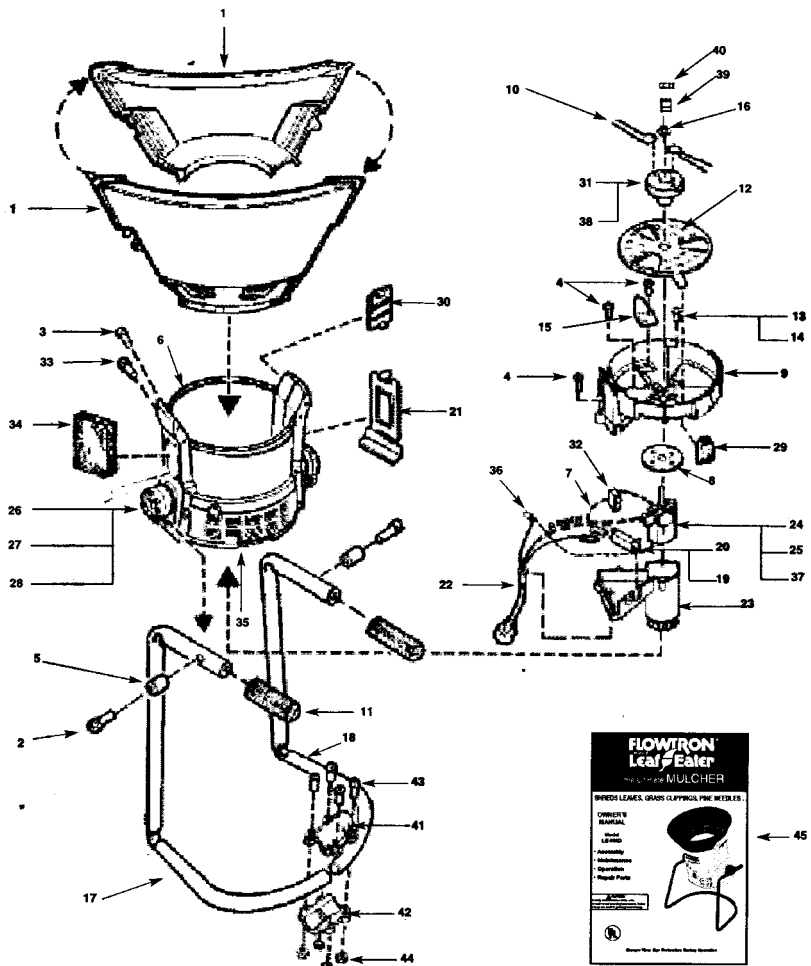

FLOWTRON LEAF-EATER THE ULTIMATE MULCHER

Parts List — FLOWTRON ELECTRIC LEAF-EATER #LE-900F

Ref. #	Part #	Description	Qty.
1	355 2118	FUNNEL	2
2	245 6237 P28	SCREW, SHT. MTL., PAN HD., PHIL, #8 X 1/2, BLK.	2
3	345 2285 P42	SCREW, PAN HD., PHIL, #10 X-3/4	2
4	345 2285 P29	SCREW, PAN HD., PHIL, #8 X 5/8	8
5	396 2599	LEG HUB SPACER	2
6	355 2117	MAIN HOUSING	2
7	305 3015	JUMPER WIRE ASSY.	1
8	352 2138	MOTOR SUPPORT PLATE	1
9	355 2116	BULKHEAD	1
10	396 2877 PO1	CUTTING LINE	2
11	396 2438	HANDLE GRIP	2
12	355 3150	MULCHING DISC	1
13	345 2978	SCREW, PHIL, HEAD, #10-24 x 5/8	2
14	245 6272 P04	#10 FLAT WASHER	2
15	352 3149	CUTOFF BRACKET	1
16	567 4675	"O" RING	1
17	368 2766 P1	LEG, LEFT	1
18	368 2767 P1	LEG, RIGHT	1
19	355 3105	SPACER, CIRCUIT BREAKER	1
20	394 3500	CIRCUIT BREAKER	1
21	355 2135	STORAGE DOOR	1
22	312 2517	POWER CORD	1
23	355 2115	MOTOR HOUSING	1
24	343 2570	BAFFLE (NOT SHOWN)	1
25	379 3449	MOTOR	1
26	355 2134	LEG KNOB	2
27	355 2133	LEG HUB	2
28	367 2574	FRICITION PAD	2
29	355 2555	ADJUSTMENT KNOB	1
30	355 2130	SWITCH COVER	1
31	305 1779	SPINNER HEAD ASSEMBLY	1
32	394 3014	SWITCH, ON/OFF	1
33	345 2285 P34	SCREW, PAN HD., PHIL, #8 X 1-1/4	6
34	367 3011	FILTER ELEMENT, REMOVABLE	1
35	396 2136	BUNGEE CORD	1
36	595 1506	WIRE CONNECTOR	1
37	345 1683	JAM WASHER, SPINNER (NOT SHOWN)	1
38	369 1689	INSERT, SPINNER (NOT SHOWN)	1
39	345 3199	TRHEADED STUD	1
40	357 3197	NUT	
41	355 2816	LEG CLAMP, UPPER	1
42	355 2817	LEG CLAMP, LOWER	1
43	245 6225 P33	SCREW, PAN HD., PHIL PARK, #8-32 X 5/8	4
44	245 6267 P44	NUT, HEX STL, PARK, #8-32, 11/32	4
45	357 3151	OWNER'S MANUAL	1

KNOW YOUR FLOWTRON ULTIMATE LEAF-EATER

Your Flowtron Ultimate Leaf-Eater is a quality built product that is designed to provide you with a unit that is affordable and will perform with a minimum of care and maintenance.

A. Special Features Include:

- Coarse to fine leaf reduction with special positions for pine needles and grass clippings.
- Unique leg design – functions upright or straddles trash barrel.
- Tilt feature makes loading easy; body of unit flips 180° for simple, compact storage.
- Bungee cord surrounding bottom of unit firmly holds leaf bag in position.
- Storage compartment with hinged door holds cutting lines, gloves, safety glasses, etc.
- Foam cushion handle grips ensure comfort and ease of carrying.
- Powerful universal electric motor.
- Runs on ordinary 120 volt, 15 amp household current.

B. Unpacking Instructions

Your unit has been carefully packed at the factory to prevent damage during shipment and storage.

Carefully unpack the carton as follows:

1. Check parts against list shown
2. Examine for damage

Carton Contents

KEY #.	DESCRIPTION	QTY.
1	FUNNEL HALF	2
2	HOUSING	1
3	LEG LEFT	1
4	LEG RIGHT	1
5	HARDWARE PACKAGE	1
6	OWNER'S MANUAL	1

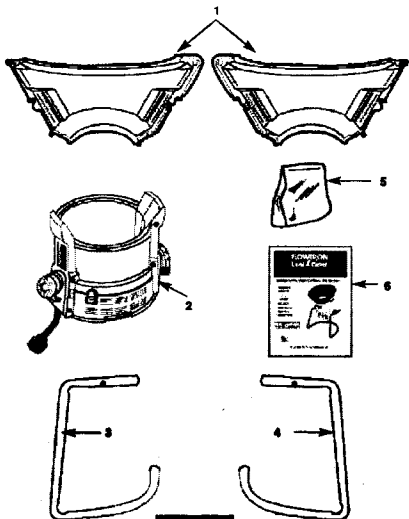

FIGURE 2

NOTE: The Right Hand, (R.H.), and Left Hand, (L.H.), sides of your FLOWTRON Ultimate Leaf-Eater are determined when standing at the rear of the machine. See Figure 1.

Hardware Bag Contents

Qty.	Description
1	Leg Clamp, Upper
1	Leg Clamp, Lower
2	#8 Pan Head Phillips Screw 1/2" long
2	Spacer
2	#10 Pan Head Phillips Screw 3/4" long
4	#8 Pan Head Phillips Screw 5/8" long
2	Handle Grips
4	#8-32 Hex Nut
36	Cutting Lines