



Tiller/Cultivator with Honda Engine

OWNER'S MANUAL



Welcome to the World of Mantis Gardening

Here's your new MANTIS Tiller . . . the lightweight wonder that's Changing the Way Americans Garden.®

Unlike big tillers, your MANTIS Tiller weighs only 21 pounds. So it lifts easily, handles smoothly, tills and weeds precisely. And, unlike other small tillers, it features serpentine tines that churn soil to ten inches deep. It creates a soft, smooth seed bed, even in problem soil.

Once you know how to use your tiller correctly, we guarantee you'll love it. So first, please read this manual. It shows, step by step, how to use your tiller safely. Plus, it shows how the MANTIS Border Edger can make light work of your edging needs.

If you have questions about any topic in this Manual or if you wish to order MANTIS attachments, contact your local authorized Mantis Dealer.



Table of Contents

Safety Rules & Warnings	3-5	MANTIS Tiller Assembly Layout	17
Safety Decals	4	Engine Parts Assemblies	18
Engine & Fuel Warnings	5	Limited Warranty Information	20
Assembly and Mixing Fuel	6-9		
Starting	10-11		
Additional Information	11		
Getting to Your Garden	11		
Tilling & Cultivating	12-13		
Tine Positioning	3		
Storage	15		
Using The Border/Edger Attachment	16		

Safety rules & warnings

You will notice throughout this Owners Manual Safety Rules and Important Notes. Make sure you understand and obey these warnings for your own protection.

I. Special Safety Information

⚠ WARNING • DANGER ⚠
**ATTENTION: THIS SYMBOL POINTS OUT
OUR IMPORTANT SAFETY INSTRUCTIONS.**

**WHEN YOU SEE THIS SYMBOL, ⚠
HEED IT'S WARNING!! STAY ALERT!!**

⚠ WARNING • DANGER ⚠
**TO REDUCE THE POTENTIAL FOR ACCIDENTS, COMPLY WITH
THE SAFETY INSTRUCTIONS IN THIS MANUAL.**

**FAILURE TO COMPLY MAY RESULT IN SERIOUS PERSONAL
INJURY, AND/OR EQUIPMENT AND PROPERTY DAMAGE.**

II. Safety & Warnings

⚠ WARNING • DANGER ⚠
**IMPROPER USE OR CARE OF THIS TILLER
OR FAILURE TO WEAR PROPER PROTECTION
CAN RESULT IN SERIOUS INJURY.**

**READ AND UNDERSTAND THE RULES FOR SAFE OPERATION
AND ALL INSTRUCTIONS IN THIS MANUAL.**

WEAR HEARING AND EYE PROTECTION.

⚠ WARNING: The Engine Exhaust from this product contains chemicals known to the State of California to cause cancer, birth defects or other reproductive harm.

III. Safety Decal Information

An important part of the safety system incorporated in this tiller are the warning and information decals found on various parts of the tiller. These decals must be replaced in time due to abrasion, etc. It is your responsibility to replace these decals when they become hard to read. The location and part numbers (P/N) of these decals are illustrated on Page 27.



P/N 400620



P/N 400609



CUTTING HAZARD; KEEP FEET AND HANDS AWAY FROM ROTATING TINES.



DO NOT CARRY THE TILLER IN THIS POSITION.



READ OWNER'S MANUAL BEFORE USING TILLER, OR PERFORMING ANY REPAIR OR MAINTENANCE. KEEP OWNERS MANUAL IN A SAFE PLACE.



DON'T FUEL, REFUEL, OR CHECK FUEL WHILE SMOKING, OR NEAR AN OPEN FLAME OR OTHER IGNITION SOURCE.



CAUTION: WHEN ASSEMBLING THE HANDLES, MAKE SURE FUEL TANK FACES AWAY FROM OPERATOR. THIS IS THE REAR OF THE TILLER, REFER TO ASSEMBLY INSTRUCTION ON PAGE 7.



INCORRECT ASSEMBLY.



WEAR EAR AND EYE PROTECTION.

⚠ WARNING • DANGER ⚠
IF THE TILLER IS USED IMPROPERLY OR SAFETY PRECAUTIONS ARE NOT FOLLOWED, THE USERS RISK SERIOUS INJURY TO THEMSELVES AND OTHERS.
READ AND UNDERSTAND THIS MANUAL BEFORE ATTEMPTING TO OPERATE THIS TILLER.

IV. Warnings - Do's

Read and understand the owner's manual. Pay particular attention to all sections regarding safety.

1. Always keep a firm grip on both handles while the tines are moving and/or the engine is running. **BE AWARE!!** The tines may coast after throttle trigger is released. Make sure tines have come to a complete stop and engine is off before letting go of the tiller.

2. Always maintain a firm footing and good balance. Do not overreach while operating the tiller. Before you start to use the tiller, check the work area for obstacles that might cause you to lose your footing, balance or control of the machine.

3. Thoroughly inspect the area where equipment is to be used and remove all objects, which can be thrown by the machine.

4. Always keep area clear of children, pets, and bystanders.

5. Always stay alert. Watch what you are doing and use common sense. Do not

operate unit when fatigued.

6. Always dress properly. Do not wear loose clothing or jewelry, they might get caught in moving parts. Use sturdy gloves. Gloves reduce the transmission of vibration to your hands. Prolonged exposure to vibration can cause numbness and other ailments.

7. While working, always wear substantial footwear and long trousers. Do not operate the equipment when barefoot or wearing open sandals.

8. Always wear ear and eye protection. Eye protection must meet ANSI Z 87.1. To avoid hearing damage, we recommend hearing protection be worn whenever using the equipment.

9. To reduce fire hazard, keep the engine, and petrol/gas storage area free of vegetative material and excessive grease.

10. Start the engine carefully, according to the manufacturer's instructions and with feet well away from tool(s).

11. Keep all nuts, bolts and screws tight to be sure the equipment is in safe

working condition.

12. Use extreme caution when reversing or pulling the machine towards you.

13. Work only in daylight or good artificial light.

14. Always be sure of your footing on slopes.

15. Exercise extreme caution when changing direction on slopes.

16. Always keep a safe distance between two or more people when working together.

17. Always inspect your unit before each use and ensure that all handles, guards and fasteners are secure, operating, and in place.

18. Always maintain and examine your Tiller with care. Follow maintenance instructions given in manual.

19. Always store tiller in a sheltered area (a dry place), not accessible to children. The tiller as well as fuel should not be stored in a house.

V. Warnings - Don'ts

Don't use tiller with one hand. Keep both hands on handles with fingers and thumbs encircling the handles, while tines are moving, and engine is running.

Don't overreach. Keep a good footing at all times.

Don't run with the machine, walk.

Don't work on excessively steep slopes.

Don't attempt to clear tines while they are moving. Never try to remove jammed material before switching the engine off and making sure the tines have stopped completely.

Don't allow children or incapable people to operate this tiller.

Don't operate while under the influence of alcohol or drugs.

Don't attempt to repair this tiller. Have repairs made by a qualified dealer or repairman. See that only original Mantis parts are used.

WARNING • DANGER

HANDLE FUEL WITH CARE, IT IS HIGHLY FLAMMABLE. FUELING A HOT ENGINE OR NEAR AN IGNITION SOURCE CAN CAUSE A FIRE AND RESULT IN SERIOUS PERSONAL INJURY AND/OR PROPERTY DAMAGE.

VI. Engine/Fuel Warnings - Do's

Always use fresh gasoline. Stale gasoline can cause damage.

Always store fuel in containers specifically designed for this purpose.

Always pull starter cord slowly until resistance is felt. Then pull cord rapidly to avoid kickback and prevent arm or hand injury.

Always operate engine with spark arrestor installed and operating properly. The use of spark arrestor mufflers is required by law in the state of California (Section 4442 of the California Public Resources Code), as well as in other states or municipalities. Federal laws apply on federal lands.

Stop the engine whenever you leave the machine.

Allow the engine to cool before storing in any enclosure.

If the fuel tank needs to be drained, this should be done outdoors.

VII. Engine/Fuel Warnings - Don'ts

Don't fuel, refuel or check fuel while smoking, or near an open flame or other ignition source. Stop engine and be sure it is cool before refueling.

Don't leave the engine running while the tiller is unattended. Stop engine before putting the tiller down or while transporting from one place to another.

Don't refuel, start or run this tiller indoors or in an improperly ventilated area.

Don't run engine when electrical system causes spark outside the

cylinder. During periodical checks of the spark plug, keep plug a safe distance from cylinder to avoid burning of evaporated fuel from cylinder.

Don't check for spark with spark plug or plug wire removed. Use an approved tester.

Don't crank engine with spark plug removed unless spark plug wire is disconnected. Sparks can ignite fumes.

Don't run engine when the odor of gasoline is present or other explosive conditions exist.

Don't operate the unit if gasoline is spilled. Clean up spill completely before starting engine.

Don't operate your tiller if there is an accumulation of debris around the muffler, and cooling fins.

Don't touch hot mufflers, cylinders or cooling fins as contact may cause serious burns.

Don't change the engine governor setting or over speed the engine.

Assembly

⚠ WARNING • DANGER ⚠

IMPROPER ASSEMBLY OF THIS TILLER CAN RESULT IN SERIOUS INJURY. MAKE SURE TO FOLLOW ALL INSTRUCTIONS CAREFULLY.

IF YOU HAVE ANY QUESTIONS CONTACT OUR FACTORY AT 1-800-366-6268 OR AN AUTHORIZED MANTIS DEALER

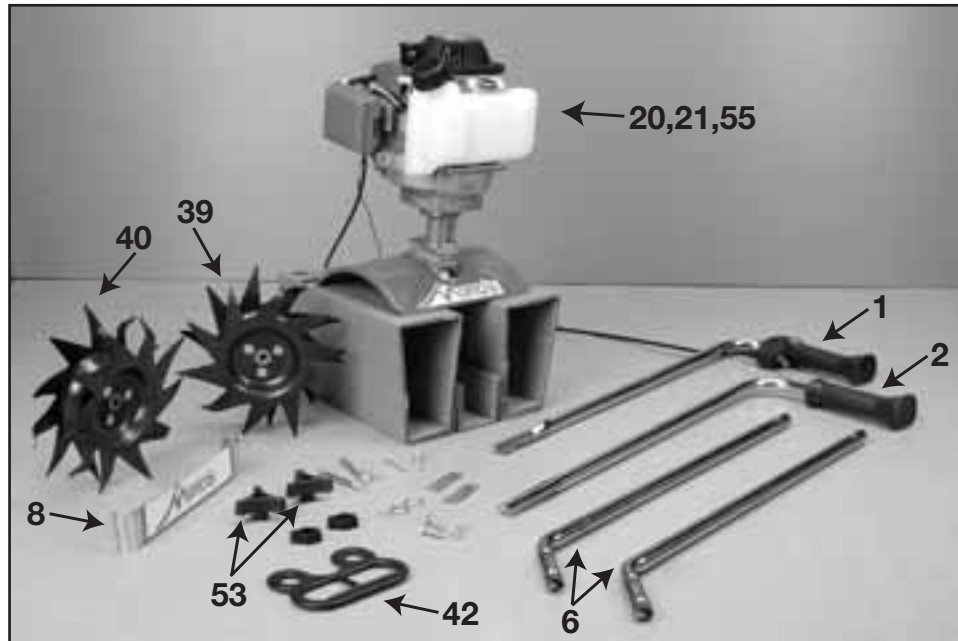

Your MANTIS Tiller comes partially assembled. You must install only the handlebars, the carrying handle, and the tines. This will take just a few minutes if you follow the directions.

First, take all items out of the carton. But do not remove the cardboard from around the Tiller's base.

The list at the right, shows the parts that come with your tiller. Check to make sure you have them.

The bag of hardware is in the plastic bag containing the Owner's Manual and Video.

To assemble your MANTIS Tiller, you'll need two 7/16" wrenches. We suggest that you install all nuts and bolts only "finger tight" — that is, one-half to one full turn — until you've completed assembly. **The nuts are self locking, but you must use a wrench to tighten them completely.**

Quantity	Description	*Key #
1	Upper Handle Assembly	2
1	Upper Handle Throttle Side Assembly	1
2	Lower Handles	6
1	Pair Tiller/Cultivator Tines	39,40
1	Engine Assembly (includes Fender Guard & Worm Gear Transmission)	20,21,55
1	Handle Brace	8
1	Plastic Carrying Handle	42
1	Bag of Hardware Containing:	
2	Cap Screws	47
4	Lock Nuts	48
2	Bolts (3" long)	49
2	Tine Retaining Pins	41
2	Handle Clamps	51
1	Throttle Clips	13
2	Bolts	52
2	Knobs	53

*These numbers are the same numbers shown on the Parts Layout on page 18.

Assembly *(continued)*

HOW TO ASSEMBLE LOWER HANDLES

To identify part numbers, see pages 6 and 18.

1. Use the protective cardboard sleeve to stabilize your tiller. Stand the engine assembly (#21) up. (Picture 1)

2. Lay the handle parts within easy reach. You'll need one of the handle clamps (#51) and one of the lower handles (#6). Note that the lower handles have a short leg on one end.

3. Fit the handle clamp along the outside of the short leg. Line up the holes on the clamp and the leg.

4. Choose one of the two 3-inch bolts (#49). Slide it through the first set of holes — near the elbow where the lower handle curves. (Picture 2 & 3)

5. Now slide the other lower

handle onto the 3-inch bolt. Fit the other clamp onto this other handle's short leg. Add a nut and tighten finger tight. (Picture 3)

6. Locate the worm gear housing. It starts just above — and extends down through — the tiller's red fender guard. You'll notice that there's a recessed channel on either side of the housing's top. (Picture 4.)

7. Take the lower handles that you've just put together. Slide them into the two recessed channels. (Picture 5.)

Make sure you insert them from the rear of the tiller . . . so that the bolt fits along the back of the housing.

8. Slide the second 3-inch bolt through the second set of holes in the short legs. Add a nut and tighten finger tight.



Picture 1



Picture 2



Picture 3



Picture 4



Picture 5

NOTE: THE LOCK NUTS ARE STAMPED. FINGER TIGHT IS APPROXIMATELY 1/2 TO 1-1/2 TURNS.

Assembly *(continued)*

How to Assemble Upper Handles and Carrying Handle

1. Lightly squeeze the lower handles (#6) toward one another so that they line up with the two smaller holes on the carrying handle (#42). Then slide the carrying handle over and down the lower handles. It will rest about four to six inches above the fender. (Picture 1)

2. Gently pull the lower handles out to their original position.

3. Attach the upper handle assembly (#1) – the handle with the throttle cable and ground wire – onto the right lower handle, and secure with the handle knob (#53). (Picture 2 and 3)



Picture 1



Picture 2



Picture 3



Picture 4



Picture 5

Note: If throttle handle is mounted on the left, it will not fold down as completely as when mounted on the right.) Be sure you have proper throttle movements and that the throttle cable is not wrapped or twisted around the handle bar. Squeeze trigger and let go.

THIS MUST BE DONE BEFORE STARTING THE ENGINE.

4. Follow the same steps to install the other upper handle onto the other lower handle. (Picture 3)

5. Use the clip (#13) to secure the throttle cable and wire in place on the lower handle. (Picture 4)

6. Now install the Handle Brace. Line it up with the holes on the upper handles. Then insert a Cap Screw and a Lock Nut on either side (Picture 5)

7. Use a wrench to tighten Cap Screws and Lock Nuts.

8. Now use wrench to tighten all nuts and bolts firmly and securely.

IMPORTANT NOTE:

Make sure you have installed the handles properly. When you stand behind your tiller, holding the handles, the gas tank is facing away from you, on the front side of the engine.

⚠ WARNING: Improper throttle installation can cause tines to rotate unexpectedly .

⚠ WARNING • DANGER ⚠
REMOVE TINES BEFORE STARTING ENGINE AND MAKING ADJUSTMENTS.

Assembly *(continued)*

Assembling the Tines for Tilling

1. Remove the cardboard from around your Tiller's base.
2. Slide the tines onto the axle shafts. The "D" hole goes on the outside.
3. Make sure you've installed the tines properly for tilling. Liken the tines to your fingers. When your palm faces the ground, your fingers curl down. Stand behind the Tiller and hold your hand next to the tines. Do the tine blades curl down, as your fingers do? If so, they are in the *tilling* position. (To switch to the cultivating position, see page 12.)
4. To secure each tine to the axle, insert a tine retaining pin.

IMPORTANT NOTE:

Before you use your MANTIS Tiller, read the Safety Rules & Warnings on pages 3-5.



IMPORTANT NOTE:

Before starting your Honda/Mantis Tiller, add the premeasured (3.4 oz.) bottle of Honda 4-cycle engine oil. See Honda Engine Manual for details.

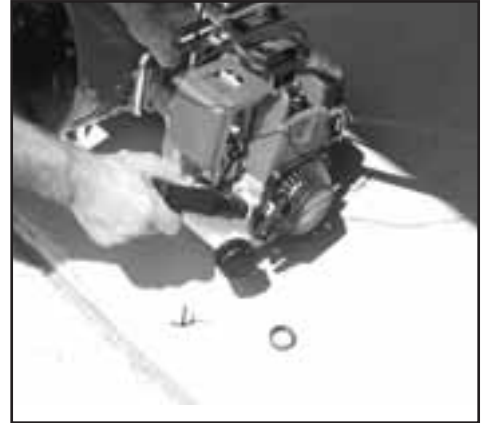

IMPORTANT NOTE:

Check the oil level in the engine before each use. Place the tiller on a level surface and rotate it forward until it rests on its gas tank. Remove the oil fill cap and make sure the oil is to the top (about to overflow). If oil is low, top it off with 10W-30 before using. See your Honda Engine Manual for details.

⚠ WARNING • DANGER ⚠

FUEL IS EXTREMELY FLAMMABLE. HANDLE IT WITH CARE. KEEP AWAY FROM IGNITION SOURCES. DO NOT SMOKE WHILE FUELING YOUR EQUIPMENT.

Never use starting fluids as they will cause permanent engine damage. Using them will void the warranty. Before you use the tiller, read the Safety & Warning rules on pages 3-6.

Starting

TO START YOUR TILLER FOR THE FIRST TIME:

First, fill the fuel tank with the proper amount of gasoline (Use branded 89 octane (R+M+2) unleaded gasoline or gasohol—maximum 10% ethyl alcohol, or 15% MTBE, no methyl alcohol.)

Mantis Tiller Starting Instructions (Honda 22cc engine)

Cold Engine

3. Place the **o/l** switch into the **l** “start/on” position. (Picture 1)

2. Choke the engine (or close the choke. Move choke up to the closed position.) (Picture 2)

3. Push primer bulb 6 times. (Picture 3)

4. Pull grip slowly until you feel resistance then pull briskly. (Picture 4)

5. Once the engine is running, slowly push the choke lever down to the run position—the engine will continue to run. (Picture 5)

Warm Engine

1. Push ignition switch to **l** “start/on” position.

↙ Push to Stop/Off Push to Start/On ↘



2. Pull grip slowly until you feel resistance then pull briskly. Make sure the choke is in the open, or run, position.

NOTE: When the choke is closed, never pull the cord more than four or five times. Over-pulling may cause flooding.

Follow these steps whenever you are starting the engine “cold”, or when the engine has run dry and you have just added fuel.

Remember, always use short, brisk pulls. Don’t give the cord a long, forceful yank. And, do not let the cord snap back into the starter housing.

How to Stop the Engine

Simply push the **o/l** “stop/start” switch to “**o**” (Picture 6).

⚠ WARNING ⚠
AVOID ACCIDENTAL BLADE ENGAGEMENT
DO NOT SQUEEZE THE THROTTLE TRIGGER WHEN STARTING.
MAINTAIN PROPER IDLE SPEED ADJUSTMENT (2500-3100 RPM)



Picture 1

This will stop the engine instantly. If it should ever fail to do so, just pull the choke up to the closed position. The engine will stop at once.

About the Choke

The choke controls the amount of air drawn into the engine. Your tiller will run only if the choke is open.



Picture 2



Picture 3



Picture 4



Picture 5



Picture 6

Additional Information

⚠ WARNING • DANGER ⚠

IF ENGINE DOES NOT STOP WHEN SWITCH IS PUT IN THE STOP POSITION, RELEASE THE THROTTLE, ALLOW ENGINE TO IDLE. PUT THE TILLER DOWN, AND SLIDE THE CHOKE LEVER FORWARD TO THE COLD START (CLOSED) POSITION. CHECK AND RETURN IGNITION SWITCH TO ON POSITION BEFORE STARTING ENGINE AGAIN.

A Special Feature (with the idle set properly and the engine running)

Even when the engine is running, the tines won't turn unless you press the throttle lever on the handlebars. And, when you release the throttle lever, the tines will stop.

A Tip for Extending Your Engine's Life

After you start the engine, let your tiller warm up for two to three minutes before you use it. Then, before you put your tiller away, let it idle for a minute to give the engine a chance to cool down.

Operation

With engine running, and both hands on the handles, press the throttle lock out button (Picture 4), then squeeze the throttle trigger gradually to increase the engine speed and engage the tines.

NOTE: This step must be repeated each time your tiller trigger is released.

NOTE: Once the throttle trigger is squeezed, you can release the lockout button (Picture 5).



Picture 4



Picture 5

How to get your tiller to your garden

Walk it.

Once your tiller is running, you can "walk" it to your garden. Just press the throttle lever gently and let the tiller "tip-toe" across your yard on its tines. It won't hurt your lawn or driveway. (Picture 1)



Picture 1

Carry It.

Make sure the engine is off. Then use one hand to grasp the convenient carrying handle. Use the other hand to hold the handlebars. (Picture 2) Then lift your tiller and carry it to your garden. Since it weighs only 21 pounds, it won't strain your muscles or tire you out!



Picture 2

Take It for a Ride.

You can easily transport your MANTIS Tiller to a friend's or relative's house. Just empty the fuel tank. (**This is crucial.**) Then stow your Tiller in the trunk of your car or truck. It fits easily. And you can put it in and take it out without straining your back.



Picture 3

Tilling/Cultivating

⚠ WARNING • DANGER ⚠

**IF YOUR TINES GET JAMMED OR ENTANGLED, SHUT OFF THE ENGINE AT ONCE.
REMOVE THE OBSTRUCTION WHILE THE ENGINE IS OFF.
NEVER TRY TO REMOVE AN OBSTRUCTION WHILE THE ENGINE IS RUNNING.
SERIOUS INJURY CAN RESULT.**

How about a family-size vegetable garden?

Nowadays many gardeners prefer small gardens — especially in the suburbs, where space is at a premium. But, if you're fortunate enough to own a large lot, you can create a bigger garden — a half acre or more. Here's how:

1. First, hire someone with a tractor or big tiller to break ground for you. This is a one-time-only investment that's well worth the small cost.

2. Then, use your Tiller to break up any remaining clumps of soil or sod. Unlike a tractor or big tiller, your MANTIS Tiller is a precision tool. It will pulverize your soil into a smooth seed bed.



Picture 1

Your MANTIS Tiller Makes Weeding a Pleasure!

As a tiller, your MANTIS Tiller works the soil down to 10" (25.4 cm) deep. But, as a cultivator, it gently cultivates the surface, only 2" to 3" (5.09 cm to 7.62 cm) deep.

First, you must switch the tines to the weeding position. This takes less than a minute.

Then, your MANTIS Tiller's sharp "tine teeth" will slice up those pesky weeds, burying them as you go along. And, since the tines in this position won't dig too deep, they won't hurt your plants' precious root systems.

The result? Your Tiller will cut your weeding time in half, and turn a tiresome chore into a pleasure.



Picture 2

How to Switch From Tilling to Cultivating Position

1. Make sure your Tiller is off.
2. Remove the retaining pins from the tines.
3. Remove the tines from the axle.

4. Place the right-side tine onto the left-side axle. Place the left side tine onto the right-side axle. The "D" hole should be to the outside.

5. Here is how to make sure you've installed the tines properly. Stand behind the Tiller and hold your hand, palm up, next to the tines. Do the tine points curl up, as your fingers do? If so, they are in the correct cultivating position. (See photos on Page 13)

6. Reinsert the pins.

Cultivating

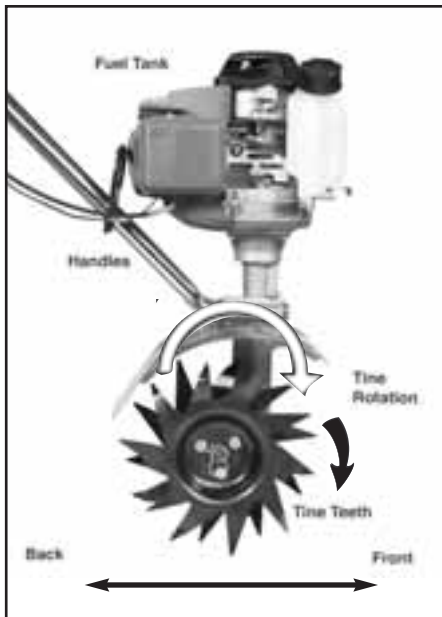

Tilling Position

Tine teeth point in the same direction as the rotation of the tine; or toward the front of the Tiller, away from the operator.

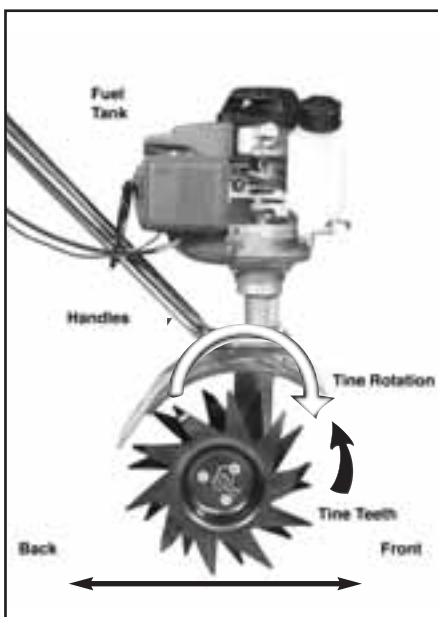

Cultivating Position

Tine teeth point in the opposite direction as the rotation of the tine. Tines point toward the back of the tiller, or toward the operator.

Now You're Ready to Cultivate or Weed.

Guide your Tiller where you want to weed and start it up. Pull your Tiller backward slowly, then let it move forward a bit, in a gentle rocking motion. Watch it slice, shred, and bury those weeds!

Got tough weeds? Lighten your pressure on the throttle to slow your Tiller down. Then work back and forth until your Tiller chops up the weeds. It's easy and effective!

Remember, any tiller will tangle in tall grass, stringy vines, or super-big weeds. So, if you have a "backyard jungle," first use a knife, pruner, or brush cutter to chop up the overgrowth. If the tines become tangled anyway, turn the engine off completely before trying to clear them.

The optional tine Detangler (Item #1322) will clear tines in a jiffy. Contact your local authorized Mantis dealer.

Your Mantis Tiller Will Weed Between Narrow Rows!

Your Mantis Tiller is a precision weeder that easily fits in tight places. So don't be afraid to weed anywhere: between plants and shrubs; in corners; against fences; on raised beds; in wide rows; even in very narrow rows. Your Mantis Tiller weeds six* to nine inches wide. So you can run it in a tightly planted garden without damaging your delicate



plants. That's good news for suburban gardeners, who often have to plant rows close together!

*With optional Planter Furrower attachment (Item #62222.)

Maintenance

How to Check the Grease Level Inside the Worm Gear Housing

When we built your MANTIS Tiller, we lubricated the worm gear housing thoroughly.

It is imperative that you inspect the grease level once a year. Simply remove the cover plate on the worm gear housing. (Picture 1) Then check to make sure the grease comes almost to the top of the housing. If it doesn't, add lithium #0 grease (Item M9985.) This is the only way to add grease to the worm gear housing. (Picture 1) To purchase Mantis grease, contact your local authorized Mantis dealer.

Please do not overfill. Too much grease can create pressure, which could cause seals to fail or the clutch to slip.

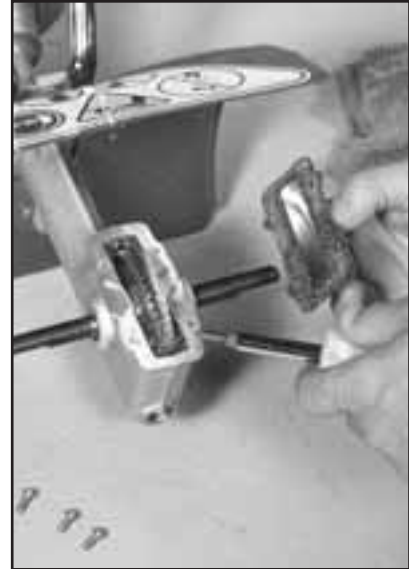

Picture 1

How to Reseat the Flange

At some point, you may find that the tines won't turn when you press the throttle. This may mean the engine isn't sitting all the way down on the worm gear housing.

Perhaps you've been using your Tiller for several years. The flange bolt (Key #12, page 18) may have come loose and lifted the engine up.

If this happened you'll notice a gap between the bottom of the engine flange (Key #43, page 18) and the top of the worm gear housing. (Picture 2)

To fix this, loosen the flange bolt. Take the engine off the worm gear housing. Notice the hex head on top of the drive shaft (Key #22, Page 18). Inside the flange housing, you'll find the clutch drum (Key #57, Page 18). Make sure the hex head

lines up with the clutch drum inside the flange housing.

Then put the engine back on the worm gear housing. Make sure the plastic carrying handle is not under the engine.

If you've followed these steps properly, there will be no gap between the engine flange and the worm gear housing. (Picture 3) Make sure you tighten the flange bolt!

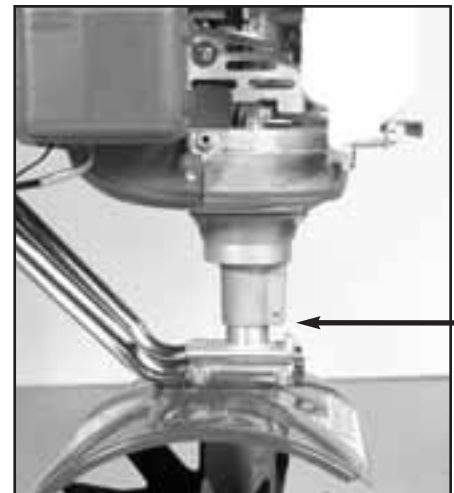

Picture 2 ... Note how the engine doesn't sit all the way down on the transmission.

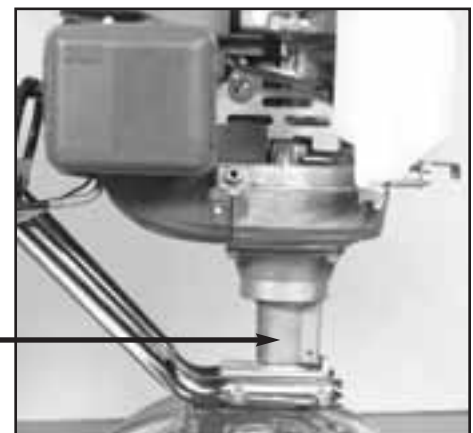

Picture 3... Note how the engine sits all the way down on the transmission.

Storage

⚠ WARNING • DANGER ⚠
**DO NOT STORE IN AN AREA
WHERE FUEL FUMES MAY ACCUMULATE
AND REACH A FLAME OR SPARK.**

Each fall, or before you store your Mantis Tiller for any long period, be sure to take these measures:

1. Do not store your Tiller with fuel still in it. Even under ideal conditions, stored fuel containing ethanol or MTBE can start to go stale in 30 days. And, since stale fuel has a high gum content, it can clog the carburetor, this, in turn, will restrict fuel flow. Therefore, when you're ready to store your Tiller, or will not be using it for more than 2 weeks, drain the fuel tank completely.
2. Next, restart the engine to make sure no fuel is left in the carburetor. Then, run the engine until it stops. This will prevent gum deposits, forming inside of the carburetor and possible engine damage.
3. Disconnect spark plug wire and remove the spark plug. Slowly pull the starter cord once.
4. Inspect the spark plug, and if necessary, clean it. If you need to replace it, buy a NGK-CMR5H.
- 5 Install the spark-plug, but leave the spark-plug wire disconnected.
6. Clean the air filter.
7. Clean dirt, grass and other materials from the entire machine.
8. Wipe the tines with oil or spray them with WD-40, to prevent rusting.
9. Oil the throttle cable and all visible moving part. (Don not remove the engine cover.)

You may store your Mantis Tiller with the handles upright as in Picture 1 or with the handles folded down, as in Picture 2.



Picture 1



Picture 2

Using the Border Edger Attachment

Your MANTIS Tiller has been designed and built to accept a wide range of MANTIS Tiller Attachments to increase its usefulness in your lawn and garden. And, all MANTIS Tiller Attachments have been designed for quick and easy attachment to the Tiller or Engine.

The Border Edger (Item #3222)

The most popular attachment, the Border Edger can be used to cut clean, neat edges along walkways, or around trees, shrubs, and garden beds.

The Border Edger has two parts: a wheel and a hardened steel blade, with pointed tines.

How to Install the Border Edger

The following instructions refer to “right” and “left” axles. Assume that you’re standing behind your Tiller, as you would for tilling and cultivating.

Some areas of your yard may harbor roots and other underground obstructions. In places like this you’ll want to edge your borders shallowly (1” to 2” deep). Here’s how to install the Border Edger for shallow edging:

1. First remove your tilling/cultivating tines.
2. Then slide the edger’s wheel onto the right axle.
3. Now slide the Edger blade onto the left axle. The blade’s angled face should hit the ground when you spin the blade forward.
4. Insert retaining pins on both left and right axles.

Around walkways and garden beds, you’ll want to edge more deeply (3” to 4” deep). Here’s how to install the Border Edger for that purpose:

1. Remove the tilling/cultivating tines.
2. Slide the Edger’s blade onto the right axle. The blade’s pointed face should hit the ground when you spin the blade forward.
3. Slide the wheel onto the left axle.
4. Insert retaining pins on both sides.

How to Use the Border Edger

1. Position your MANTIS Tiller so that the Edger blade is right along the garden edge and the wheel is outside (on the lawn, on the sidewalk, wherever). (Picture 1)
2. Start your Tiller and pull your MANTIS backward along the garden edge. (Picture 2)



Picture 1

The Border Edger Can Handle Special Projects!

1. Install the Edger for deep edging, as directed above. Then use it to cut sod strips.
2. Edge and weed at the same time! Just attach the Edger blade on one axle and a Tiller tine on the other axle, “Mix and match” blades; don’t be afraid to experiment.

IMPORTANT NOTE:

If you do a lot of edging, you’ll appreciate the MANTIS Wheel Set (Item#9222.) It gives you added stability, for even easier handling.

To order the Wheel Set, or any Mantis Attachment, contact your local authorized Mantis dealer.

Mantis Tiller Assembly

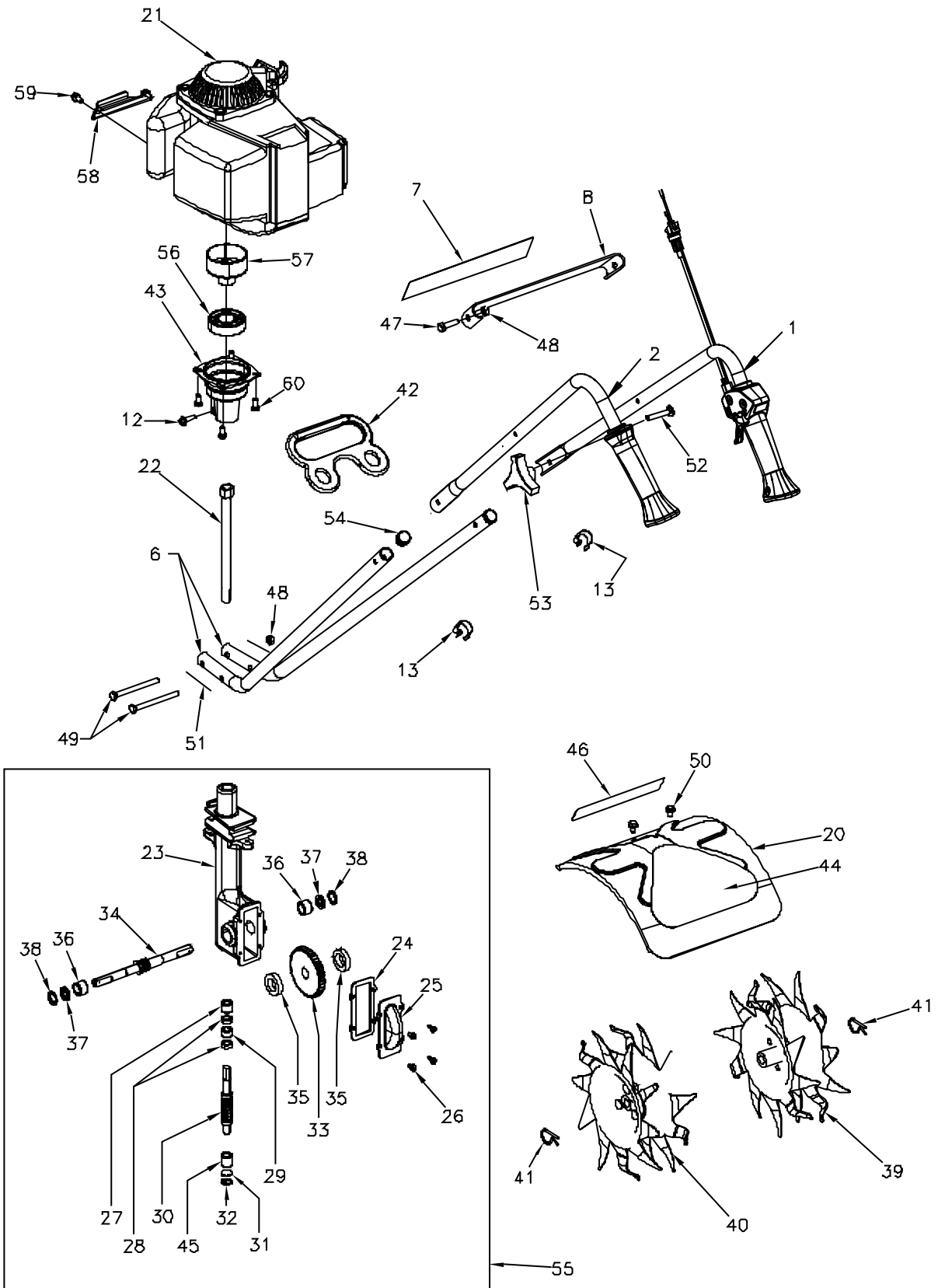

Mantis Tiller Assembly

<u>KEY #</u>	<u>QTY</u>	<u>MATERIAL</u>	<u>KEY #</u>	<u>QTY</u>	<u>MATERIAL</u>
1	1	400257 TRIGGER HANDLE ASSM. RH	34	1	431 TINE SHAFT
2	1	400255 HANDLE ASSM. LH	35	2	430 WORM GEAR THRUST WASHER
6	2	400224 LOWER HANDLE - FOLD DOWN	36	2	432 WORM GEAR BEARING
7	1	400620 LABEL	37	2	434 BEARING
8	1	148 HANDLE BRACE	38	2	435 BEARING SEAL RETAINER
12	1	910502 10-32 X 3/4 - FLANGED BOLT	39	1	438RA TINE ASSY - RT
13	2	478 THROTTLE CLIP	40	1	438LA TINE ASSY - LT
20	1	465 FENDER GUARD	41	2	418-1 TINE RETAINING HAIR PIN
21	1	400911 ENGINE ASSY - 25cc HONDA	42	1	400133 CARRYING HANDLE
22*	1	468 DRIVE SHAFT	43	1	400130 ENGINE FLANGE
23	1	466 WORM GEAR HOUSING	44	1	400609 TINE LABEL
24	1	436 GASKET	45	1	458 ROLLER BEARING
25	1	437A HOUSING COVER	46	1	4058 MANTIS LABEL
26	4	651 RD. HD. SELF TAPPING SCREW	47	2	410 CAP SCREW 1/4-20 X 1" LG.
27	1	423 ROLLER BEARING	48	4	972 LOCK NUT 1/4 - 20
28	2	425 WORM BEARING RACE	49	2	470 1/4-20 X 3.25 BOLT
29	1	424 WORM THRUST BEARING	50	2	140 BOLT 1/4 - 20 X 3/8" LG.
30	1	422 WORM SHAFT	51	2	377 HANDLE CLAMP
31	1	426 WORM DISK	52	2	400509 BOLT
32	1	428 RETAINING RING	53	2	400510 KNOB
33	1	429 WORM GEAR	54	2	400230 PLUG
			55	1	400010 TRANSMISSION ASSEMBLY
			56	1	400132 BEARING
			57	1	400131 CLUTCH DRUM
			58	1	400134 GAS TANK GUARD
			59	2	400512 M5 X 13 - SELF TAPPING BOLT
			60	4	400511 M6 X 12 - FLANGED BOLT

* Also in Key #55

Notes

Limited Warranty Information for Mantis Tiller

MANTIS extends this limited warranty against defects in material and workmanship for a period of two years from the date of purchase, to the first retail purchaser and each subsequent owner during the warranty period. This warranty covers all portions of the MANTIS Tiller.

MANTIS will repair or replace, at its option, any part or parts of the product proven to be defective in material or workmanship under normal usage during the warranty period. Warranty repairs and replacements will be made without charge for parts or labor. All parts replaced under warranty will be considered as part of the original product, and any warranty on the replaced parts will expire coincident with the original product warranty. In the event of a defect or malfunction, the purchaser must send the product, postage paid to:

Mantis
2800 Turnpike Dr.
Suite #1
2800 Commerce Center
Hatboro, PA 19040

MANTIS assumes no responsibility in the event that the product was assembled or used in noncompliance with any assembly, care, safety, or operating instructions contained in the Owner's Manual; was not

used with reasonable care; or was misused, used for other than normal or intended purposes. This warranty does not extend to parts affected or damaged by normal wear and tear.

MANTIS MAKES NO EXPRESS OR IMPLIED WARRANTIES OR REPRESENTATIONS EXCEPT THOSE CONTAINED HEREIN. THE DURATION OF ANY IMPLIED WARRANTY, INCLUDING MERCHANTABILITY AND FITNESS FOR A PARTICULAR PURPOSE, IS LIMITED TO THE DURATION OF THIS WRITTEN LIMITED WARRANTY. MANTIS DISCLAIMS ALL LIABILITY FOR INDIRECT AND/OR CONSEQUENTIAL DAMAGES. SOME STATES DO NOT ALLOW LIMITATIONS ON HOW LONG AN IMPLIED WARRANTY LASTS AND/OR DO NOT ALLOW THE EXCLUSION OR LIMITATION OF INCIDENTAL OR CONSEQUENTIAL DAMAGES, SO THAT ABOVE LIMITATIONS AND EXCLUSIONS MAY NOT APPLY TO YOU. THIS WARRANTY GIVES YOU SPECIFIC LEGAL RIGHTS, AND YOU MAY ALSO HAVE OTHER RIGHTS WHICH VARY FROM STATE TO STATE.

MANTIS
1028 Street Road
Southampton, PA 18966
(215) 355-9700

Specifications, descriptions, and illustrative material in this literature are as accurate as known at the time of publication, but are subject to change without notice.